

Dometic-Aire™

Roof-Top Air Conditioner

HEATER KIT

NO. A70011

INSTALLATION INSTRUCTIONS

INSTALL BEFORE STARTING FIG 7 IN YOUR AIR CONDITIONER INSTALLATION MANUAL

Use with Dometic-Aire Roof Top Air Conditioner

Model Nos: QC110, QC135
QC110R, QC135R

**THIS HEATER KIT IS AVAILABLE AS AN OPTION
FROM YOUR DOMETIC DEALER.**

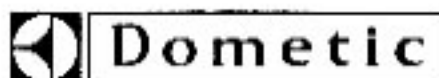

INSTALLATION - INSTRUCTION

DOMETIC HEATER KIT - A70011

Remove control panel from air distribution box. Disassemble air box housing by removing six #8 X 1/2" Lg. screws. Slide thermobulb out from holder and remove six #8 X 1/2" Lg. screws holding ceiling retainer plate in place. Disassemble control box from channel supports by removing four #8 X 1/2" Lg. blunt point screws (See Fig. 1). Let control box hang down inside coach.

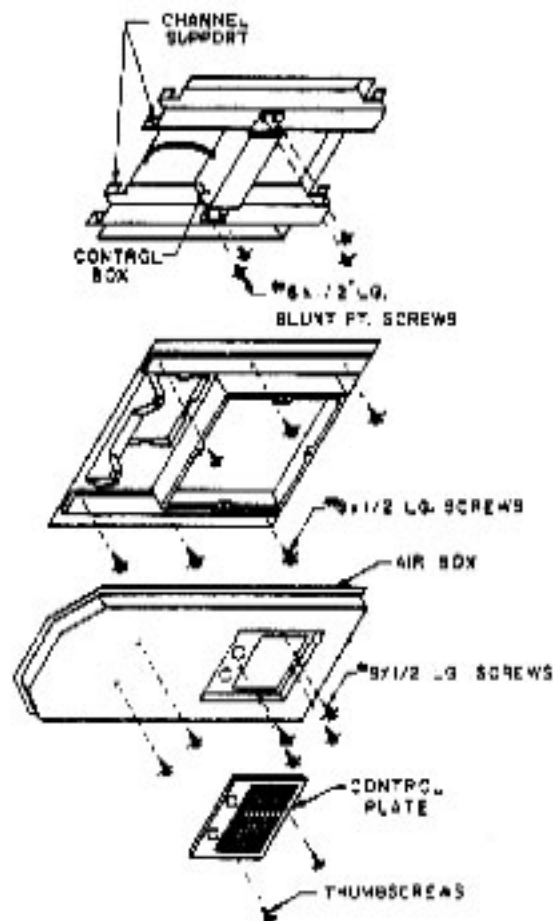

Figure 1

Tilting heater upward (See Fig. 2) slide through channel supports and base pan. Position heater onto weld studs provided on partition (See Fig. 3). While holding heater in place with one hand, attach hex nuts to weld studs. Tighten down nut with ratchet. Using right hand, grasp heater plug and insert into connector located on partition. Note if plug does not insert, rotate 180° (See Fig. 4).

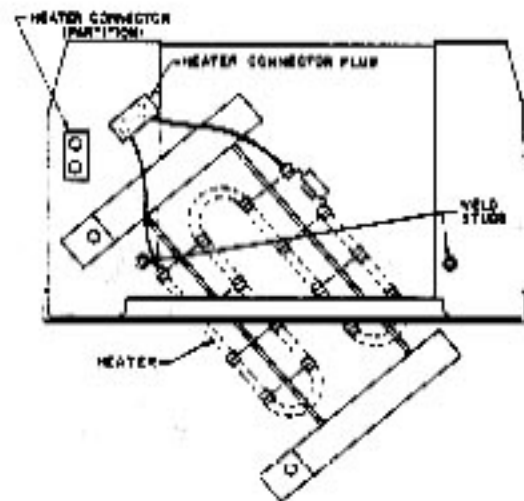
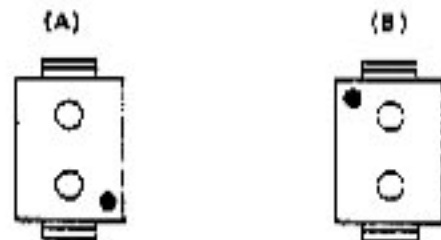

Figure 2



INSERT PLUG WITH INDICATOR AS IN (A). IF PLUG DOES NOT INSERT ROTATE 180° (B).

Figure 3

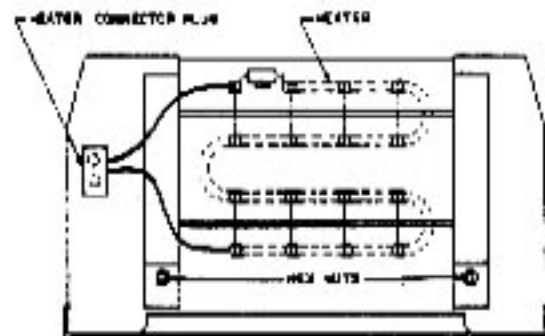
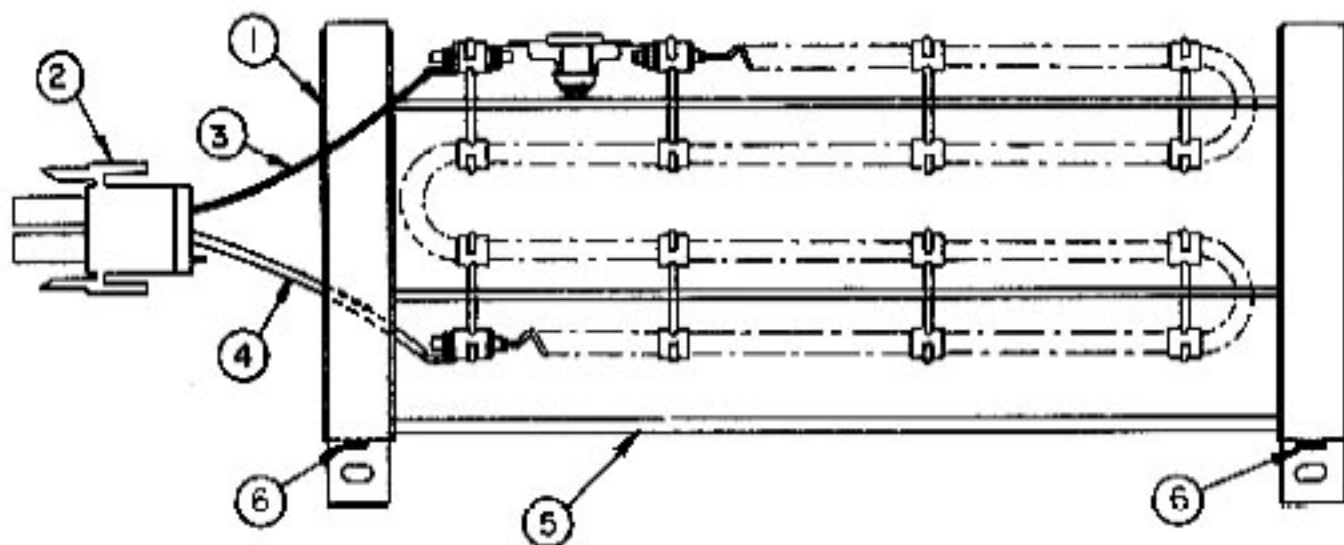

Figure 4

After heater is installed, reattach control box to channels being sure to use four #8 X 1/2" Lg. blunt point screws. Reassemble ceiling plate, air box housing and control panel respectively. Make sure to place thermobulb back into holder.

New heat/cool control decal is located in parts envelope. Remove protective backing and affix (adhesive side toward panel) to control plate. It is not necessary to remove existing control plate.



6	Y05154	SCREW	2
5	S40611	HEATER SHIELD	1
4	E18491	JUMPER WIRE (WHITE)	1
3	E18492	JUMPER WIRE (BROWN)	1
2	E16461	CONNECTOR HOUSING	1
1	E50191	HEATER	1
ITEM	PART NO.	NAME-OF-PART	QUANTITY

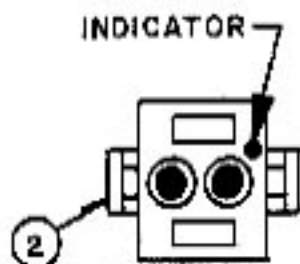

NOTE -
WHITE WIRE MUST BE
INSERTED INTO HOUSING
HOLE WITH INDICATOR.

**DOMETIC
SALES CORPORATION**

2320 Industrial Parkway
P.O. Box 400
Elkhart, IN 46515
(219) 294-2511

8155 Bryan Dairy Rd.
Largo, Fla. 33543
(813) 397-1465

14441 Bonelli St.
City of Industry, CA 91746
(213) 968-9431

7895 S.W. Hunziker Rd.
Portland, OR 97229
(503) 620-9510

902 Ave. E
Grand Prairie, TX 75050
(214) 641-4277

East Oak Ridge
Route 9, Box 17A
Hagerstown, MD 21740
(301) 797-0826

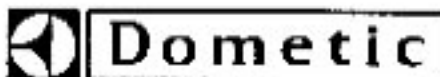

Heating Capacity (BTU/HR)	5,100
Full Load Amps	15.5
Volts - AC	115
Min. Circuit Ampacity (with heater)	18.7